

Scan System(F)

Network Scanner

Operation Guide <Set-up Edition>

ALWAYS read this Operation Guide thoroughly before use. After reading, maintain it in good condition and keep it together with the Operation Guide for your products.

Note This Operation Guide contains information that corresponds to using both the inch and metric versions of this machine.

This Operation Guide shows messages of the inch version. When using the metric version, see the messages of the inch version for reference. With regard to the messages in the text, if a message has only the difference of upper- and lower-case spelling, we show only the message of the inch version. When there is even a slight difference in the message, we have listed the information for the inch version followed, in brackets, by the corresponding information for the metric version.

Trademark Information

- Microsoft, Windows, Windows NT and Internet Explorer are registered trademarks of Microsoft Corporation of America and other countries.
- Windows Me , Windows Server and Windows XP are trademarks of Microsoft Corporation.
- Ethernet is a registered trademark of Xerox Corporation.
- IBM and IBM PC/AT are trademarks of International Business Machines Corporation of America.
- Adobe and Acrobat are registered trademarks of Adobe Systems Incorporated.
- PaperPort is a registered trademark of ScanSoft Inc. of America and other countries.

All other company and product names contained in this Operation Guide are trademarks or registered trademarks of their respective companies. The designations TM and ® will not be used in this Operation Guide.

All rights reserved. No part of this material may be reproduced or transmitted in any form or by any means, electronic or mechanical, including photocopying, recording or by any information storage and retrieval system, without permission in writing from the Publisher.

Legal Restriction On Copying

- It may be prohibited to copy copyrighted material without permission of the copyright owner.
- It is prohibited under any circumstances to copy domestic or foreign currencies.
- Copying other items may be prohibited.

About this Operation Guide

This Operation Guide is meant to be read when the Scanner Interface Card is installed and your copier is to be used as a network scanner. It explains set-up procedures and other related operation on the machine.

As the required set-up in order to use the copier as a scanner may differ depending upon the environment in use in the connected computer, please read those sections related to your specific computer environment and perform the appropriate set-up procedures explained there.

This Operation Guide should also be read and used together with the appropriate Operation Guide <Functions Edition> (On-Line Manual) that is on the included CD-ROMs. The On-Line Manual <Functions Edition> explains how to scan, various setting methods, and operation procedures from a computer.

Using the Operation Guide <Functions Edition> (On-Line Manual)

The CD-ROMs included with this product contain the Operation Guide <Functions Edition> (On-Line Manual) in a PDF (Portable Document Format) file format.

The Operation Guide <Functions Edition> (On-Line Manual) explains how to use the required applications when using your copier as a network scanner. The main content of the CD-ROMs is as follows:

- Introduction of the network scanner system
- Explanation of setting procedures when using an Internet Web browser
- Explanation of setting procedures at the scanner
- Explanation of attached utilities:
 - Scanner File Utility
 - Address Book
 - Address Editor
 - TWAIN Source
 - Configuration tool

Opening the On-Line Manual

Carry out the following procedures in order to open and view the On-Line Manual.

- 1** Insert the appropriate CD-ROM into the CD-ROM drive of your computer. The Main Menu screen for set-up will appear automatically.
- 2** Click on **[Documents]** under the **[Main Menu]** in order to access the desired On-Line Manual for viewing.

Note Adobe Acrobat Reader must be installed in your computer in order to access the On-Line Manual. The Adobe Acrobat Reader software is included on the CD-ROMs contained with this product and can be installed from there directly onto your hard disk.

Important:

The use of scanned legally copyrighted materials, such as documents, musical scores, pictures, woodblock prints, maps, drawings and photographs, for any intent other than your own personal or home use, or other such purpose, is prohibited under the copyright law without prior permission from the legal copyright owner.

Simply scanning the following items may result in legal penalty:

Bank notes, coins, government-issue securities, national bonds, local bonds, foreign currencies and securities, unused postage stamps, government post cards, government stamps, and securities regulated by the liquor tax law.

Other items that you should also not scan:

It is additionally recommended that you do not attempt to scan government-issue passports, or licenses, permits, ID cards, securities, commuter tickets, passes, books of tickets and meal coupons issued by public organizations or private parties.

Getting connected

The following procedures are required in order to use this machine as a scanner.

Connect the scanner to your computer

<Example connection>

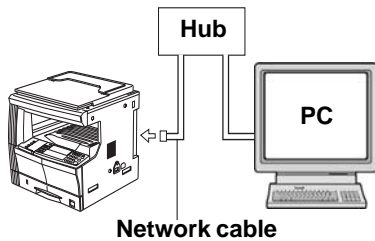

Connecting the scanner to your computer network with a network cable (100BASE-TX and 10BASE-T) **page 2-2**



Perform the required operation at the scanner

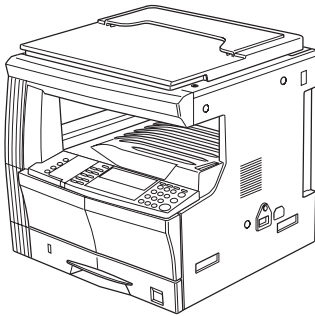

Basic scanner settings (register the host name and IP address, etc.) **page 2-3**

Date/time and time difference settings **page 2-4**



Perform the required operation at your computer

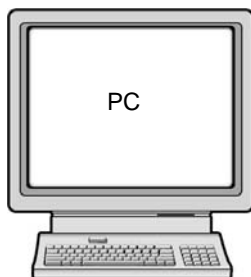

Registering and editing user information

Registers users (transmitters) who use the scanner.
See the Online Manual <Functions Edition>.

Installing the various software (included on the enclosed CD-ROM disk)

Scanner File Utility

Saves the scanned image as a data file on your computer.

TWAIN Source

Enables you to operate scanning from a TWAIN-compatible application.

Address Book

A personal address book that you can access from the scanner's operation panel.

Address Editor (Management Tool)

Enables you to register and edit the shared Address Book, make network-related settings and change various default settings. Refer to the On-Line Manual <Functions Edition> for more detailed information on the included software.



You're now ready to scan!

Table of contents

1	Preparations	1-1
	Names of parts	1-1
	Main body	1-1
	Operation Panel	1-2
	Accessories	1-3
	Utilities and other software (the main content of the included CD-ROMs)	1-3
	Required items	1-3
2	Set-up	2-1
	Setting up the scanner	2-1
	Outline and network configuration	2-1
	Connecting the scanner to your computer network	2-2
	Network (TCP/IP) settings	2-3
	User registration	2-4
	Date/Time and Time Difference	2-4
	Other settings	2-5
	Setting up the scanner software	2-6
	System requirements	2-6
	Installing the software	2-6
	Installing the utilities	2-7
	Installing the TWAIN source	2-8
3	Performing the Required Operation at the Scanner	3-1
	Scanning under the Scan to PC and Send E-mail functions	3-1
	Before using the Scan to PC function	3-1
	Before using the Send E-mail function	3-1
	How to scan under Scan to PC and Send E-mail	3-1
	Sending information	3-3
	Scanning with TWAIN	3-4
	When performing the scanning operation at the scanner	3-4
	When performing the scanning operation at your computer	3-5
	Scan setting	3-6



1 Preparations

Names of parts

Main body

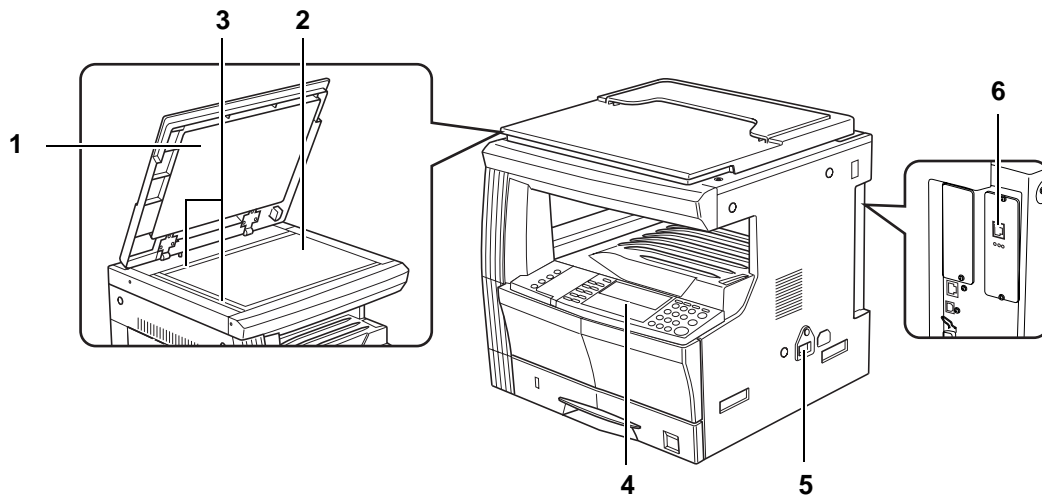

- 1 **Original cover** — Open and close this cover when setting an original on the platen.
- 2 **Platen** — Set the original to be scanned face-down in the left-rear portion of the platen.
- 3 **Original size indicator lines** — Be sure to align the original with these lines when setting an original on the platen.
- 4 **Operation panel** — Perform operations here.
- 5 **Main switch** — Turn this switch ON (I) when using the scanner.
- 6 **Scanner interface connector** — Use to connect the scanner to the computer network with a 10BASE-T or 100BASE-TX cable.

Important! NEVER attempt to remove the Scanner Interface Card.

Operation Panel

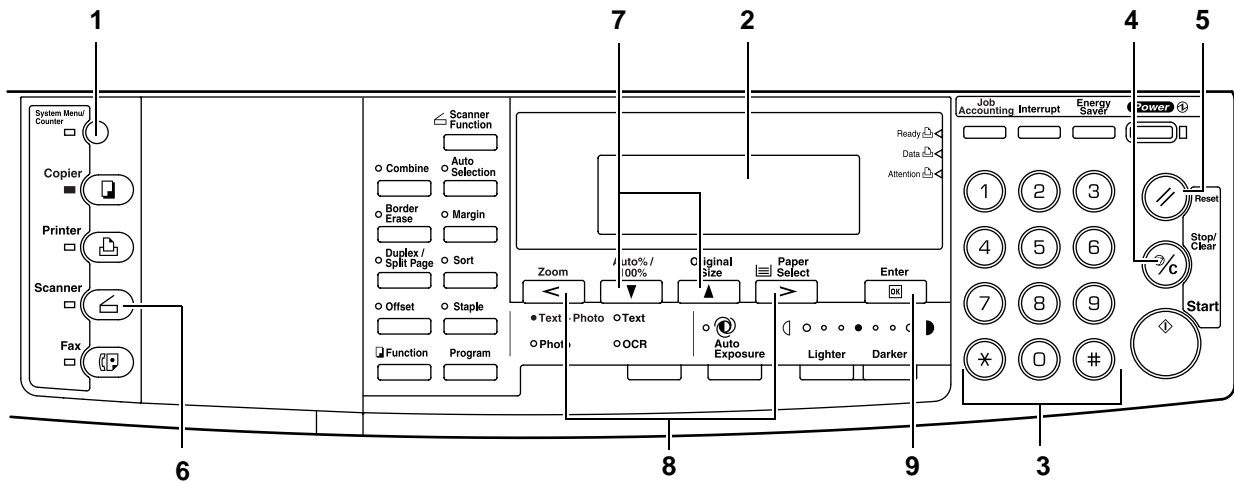

- 1 **System Menu/Counter key** — Press this key when you want to set the network address, the date/time, and the time difference of this scanner.
- 2 **Message display** — Indicates the scanner condition or setting values.
- 3 **Numeric key** — Press these keys when you want to enter a desired value directly. If there is a number in front of the selection item, you can select the item with these Numeric keys.
- 4 **Stop/Clear key** — Press this key when you want to cancel setting and return to the previous screen.
- 5 **Reset key** — Press this key when you want to cancel initial setting change or date/time setting.
- 6 **Scanner key** — Press this key when you want to switch the machine to the scanner mode. When the scanner mode is selected, the scanner indicator will light up.
- 7 **▲ and ▼ cursor keys** — Press these keys to select an item in various settings.
- 8 **< and > cursor keys** — Press these keys to change the date/time setting.
- 9 **Enter (OK) Key** — Press this key when you want to register a setting. Press this key when scanning is completed

Accessories

Prior to using the scanner for the first time, verify that the following accessories are included with this product.

- 1 CD-ROM (Scanner Library)
- 1 CD-ROM (TWAIN-compatible application)
- Operation Guide

Utilities and other software (the main content of the included CD-ROMs)

CD-ROM (Scanner Library)

- Scanner File Utility
- TWAIN Source
- Address Book
- Address Editor
- Configuration Tool
- Acrobat Reader
- On-Line Manual
- Read me

Note Refer to the On-Line Manual <Functions Edition> of this Operation Guide for information on using the included utilities and other software.

CD-ROM (TWAIN-compatible application)

Required items

You must have on hand one of the following cables as appropriate to your computer network environment.

- 100BASE-TX cable (shielded type)
- 10BASE-T cable (shielded type)

Note Be absolutely sure that the 10BASE-T or 100BASE-TX cable that you use is a shielded cable.

2 Set-up

Setting up the scanner

Outline and network configuration

Example of transmission modes for data scanned using the Scan System and the required software
The software indicated in the thick-lined balloons is included with this product. Install the software that is appropriate to your operating environment and needs.

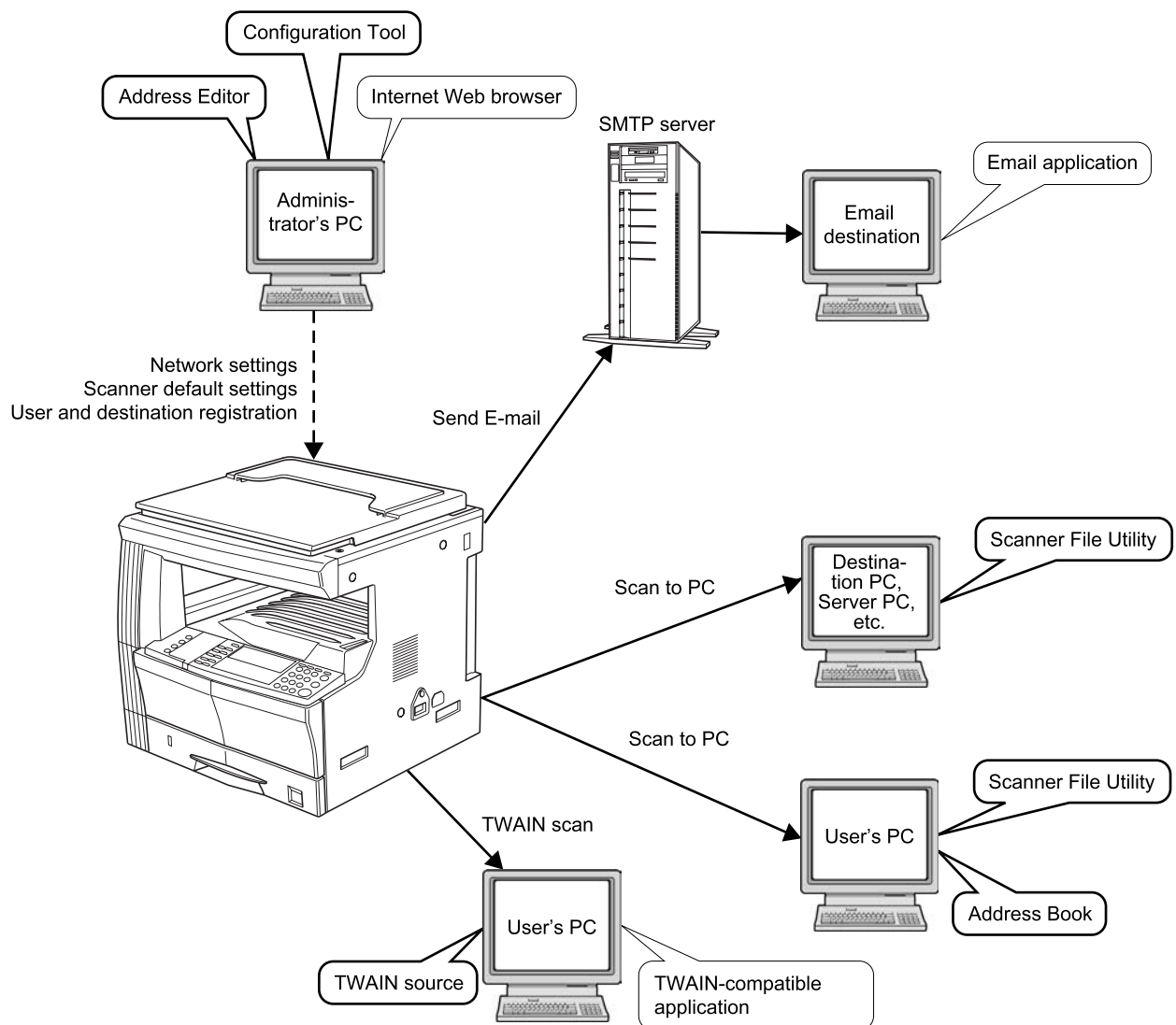

Note Refer to the On-Line Manual <Functions Edition> for information on using the included utilities and other software.

Connecting the scanner to your computer network

- 1 Turn the main switch located on the right side of the scanner OFF (O).

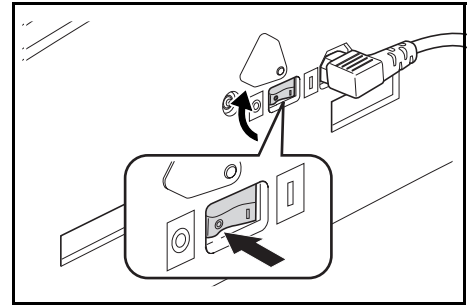

Caution ALWAYS turn the main switch to the scanner OFF BEFORE connecting the network cable.

- 2 Connect a 10BASE-T or 100BASE-TX cable to the scanner interface connector located at the back side of the right side of the scanner.

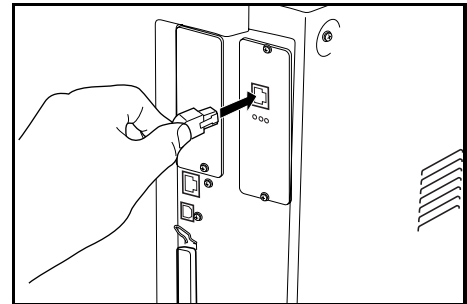

Important! NEVER attempt to remove the Scanner Interface Card.

- 3 Turn the main switch to the scanner back ON (I).

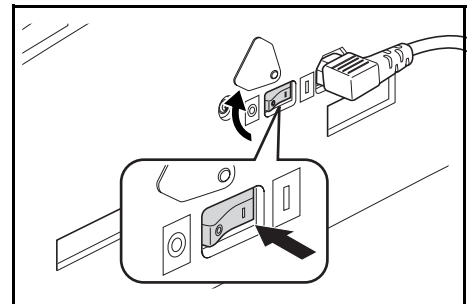

Network (TCP/IP) settings

This section explains the procedures to set the network address for the scanner.

- Notes**
- The network address that should be set here will differ depending upon your network environment. Check with your network administrator BEFORE performing this setting.
 - If you are using a DHCP server to set the network addresses, you will not need to change the IP address and the subnet mask because the DHCP has been enabled (ON) as the factory default setting.

- 1** Press the **System Menu/Counter** key to display the Default setting screen.

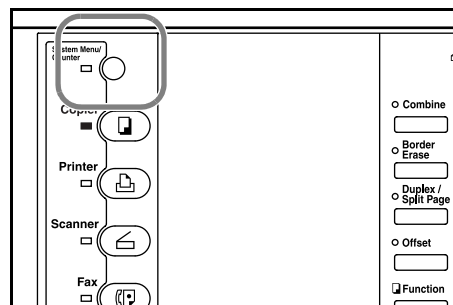

- 2** Use the ▲ and ▼ keys to move ⇨ to select **Scan default** and then press the **Enter** key. The password entry screen will appear.

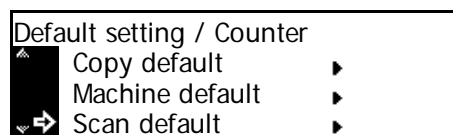

- 3** Enter the password with Numeric keys. The password at the factory default setting is **1600** for the 16 ppm model, **2000** for the 20 ppm model and **2500** for the 25 ppm model.

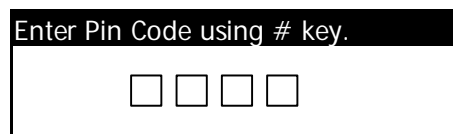

- Notes**
- If the password matches, the screen will change to the Scanner setting screen.
 - Four-digit password can be changed. Refer to the Operation Guide of machine.

- 4** Use the ▲ and ▼ keys to move ⇨ to select **DHCP** and then press the **Enter** key. Screen will change to the DHCP/BOOTP setting screen.

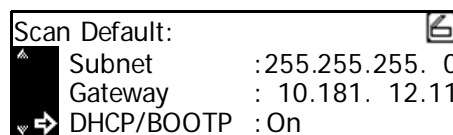

- 5** Use the ▲ and ▼ keys to move ⇨ to select **1 Off** and then press the **Enter** key. Screen will return to the Scanner setting screen of Step 4.

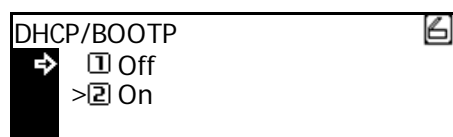

- Note** If you are using a DHCP server, select **2 On**. In this case, even if you enter each IP address and subnet mask manually, the entered settings will be ignored.

- 6** Use the ▲ and ▼ keys to move ⇨ to select **IP address** and then press the **Enter** key. Screen will change to the IP address setting screen.

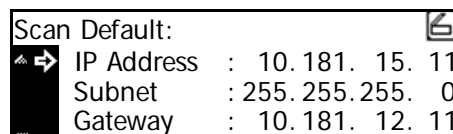

- 7** Enter the IP address by every three digits with Numeric keys. Press > key to move to the following three digits. Check the entered IP address and then press the **Enter** key if it is correct. Screen will return to the Scanner setting screen of Step 6.

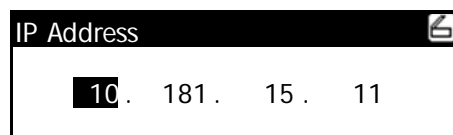

- 8 In the same manner, set `Subnet` for subnet mask and `Gateway` for gateway addresses.

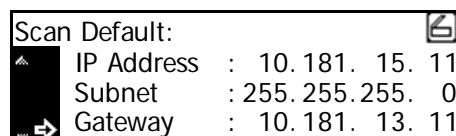

- 9 Once it is complete to enter all network addresses and returned to the Scanner setting screen of Step 7, use the **▲** and **▼** keys to move **⇒** to select `End` and then press the **Enter** key.

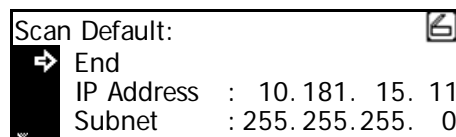

Note In a network environment with RARP, select `RARP` and then select `On` on the Scanner setting screen. In this case, you will not need to set the IP address manually.

- 10 For other network settings, use a web browser or Address Editor.

User registration

To use the scanner, user registration is needed in addition to the network setting. User (transmitter) registration is performed from a web browser or Address Editor. For details, see the Online Manual <Functions Edition>.

Date/Time and Time Difference

Sets the required area information for the Send E-mail function. The time of day when email is sent from the scanner is included in the header of that email message as the transmission time. Perform the following procedure in order to set the date and time in your area, as well as the time difference to GMT (Greenwich Mean Time).

- 1 Press the **System Menu/Counter** key.

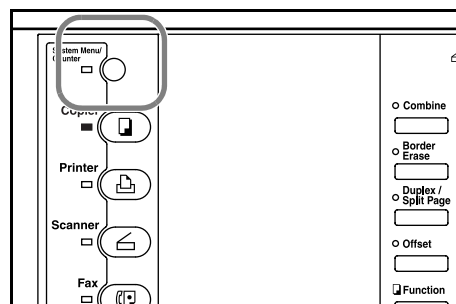

- 2 Use the **▲** and **▼** keys to move **⇒** to select `Machine Default` and press the **Enter** key. The password entry screen will appear.

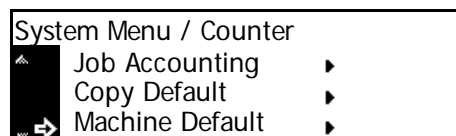

- 3 Enter the password using the numeric keys. The password at the factory default setting is **1600** for the **16 ppm** model, **2000** for the 20 ppm model and **2500** for the 25 ppm model.

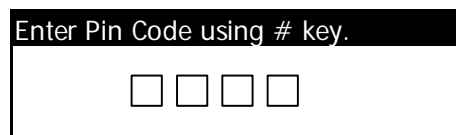

- 4 Use the **▲** and **▼** keys to move **⇒** to select `Date/Time` and press the **Enter** key.

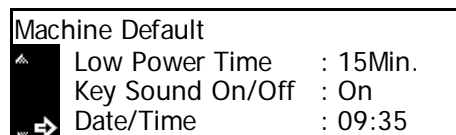

- 5 Use the **▲** and **▼** keys to move **⇒** to select the item to be changed and use the **<** and **>** keys to select the desired setting.

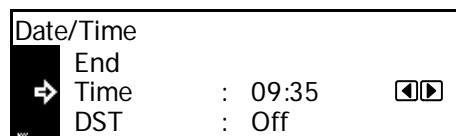

Note Set the time difference and then the date and time.

- 6** After completing the settings, move \rightarrow to select **End** and press the **Enter** key. The settings will be registered.

Date/Time	
\rightarrow End	
Time	: 09:35
DST	: OFF

Note If you change both the summer time and date/time settings, the summer time setting will be ignored.

Other settings

It is possible to change certain default settings for the scanner function. Refer to the Online Manual for details on each setting.

Setting up the scanner software

System requirements

PC	IBM PC/AT or compatible	
OS	Windows 95 (OSR2), Windows 98 (Second Edition), Windows NT 4.0 (Service Pack 5 or later), Windows 2000 (Service Pack 2 or later), Windows Me, Windows XP or Windows Server 2000	
System environment	CPU	Pentium 133 MHz or faster
	RAM	64 MB or more
	HDD	20 MB or more
Recommended environment	CPU	Celeron 500 MHz or faster
	RAM	128 MB or more
	HDD	300 MB or more
CD-ROM drive	1 drive	
Ethernet cable	10BASE-T or 100BASE-TX	

Installing the software

There are three main functions available with this network scanner. Perform the following procedure in order to install into your computer the required utility that is appropriate to the application and operating system in use in your computer.

Scan to PC

Stores the image data of scanned originals as a file in a desired folder on your computer. Install the Scanner File Utility into the corresponding computer in order to use this function.

- Note**
- Registration of the save folder in your computer, as well as registration in the scanner of the destination is required.
 - For information on making settings from an Internet Web browser, as well as for each utility, refer to the On-Line Manual <Functions Edition> of this Operation Guide.

Send E-mail

Sends the image data of scanned originals to the desired receiver as a file attached to an email message.

- Note**
- Registration in the scanner of the corresponding SMTP server settings is required. For information on making settings from an Internet Web browser, as well as for each utility, refer to the On-Line Manual <Functions Edition> of this Operation Guide.

TWAIN

Connects to the scanner from the TWAIN-compatible application according to the procedures of that particular application. Install the TWAIN Source on the computer that contains the application in order to use this function.

Installing the utilities

The following utilities are contained on the CD-ROM that is included with this product.

Note Refer to the On-Line Manual <Functions Edition> of this Operation Guide for information on using the included utilities.

- Scanner File Utility
- Address Book
- Address Editor (Management Tool)

1 Run Windows.

Quit all other applications that may be open.

2 Insert the CD-ROM that is included with the scanner into the CD-ROM drive of your computer.

3 The License Agreement will be displayed. If you agree with the conditions contained therein, click on **[Accept]**.

If this screen does not appear after you insert the CD-ROM, open the CD-ROM window to access its contents and double-click on the [setup.exe] file.



4 Click on **[Scanner Utilities]** in the Main Menu.

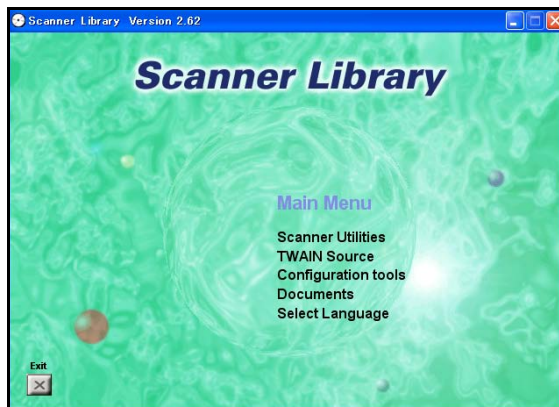

5 Click on the name of the utility that you want to install. The installation window for that utility will appear. Follow the instructions on screen in order to install the selected utility.

Installing the TWAIN source

In order to scan originals using PaperPort, TWAIN Source must be installed PRIOR to installing the PaperPort application.

- 1 Run Windows.
Quit all other applications that may be open.
- 2 Insert the CD-ROM that is included with the scanner into the CD-ROM drive of your computer.
- 3 The License Agreement will be displayed. If you agree with the conditions contained therein, click on **[Accept]**.

If this screen does not appear after you insert the CD-ROM, open the CD-ROM window to access its contents and double-click on the [setup.exe] file.

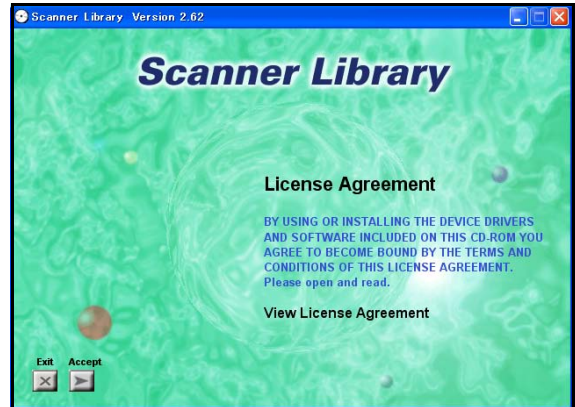

- 4 Click on **[TWAIN Source]** in the Main Menu.

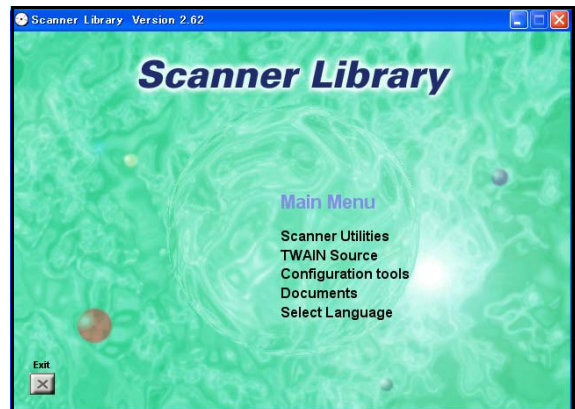

- 5 The Model Select window will appear. Select the model of the scanner that you are using.
- 6 When the installation window appears, follow the instructions on screen in order to install the TWAIN Source.

3 Performing the Required Operation at the Scanner

Scanning under the Scan to PC and Send E-mail functions

Before using the Scan to PC function

When performing the Scan to PC function, perform the following settings in advance.

- 1 Install the Scanner File Utility in the destination computer.
- 2 Run the Scanner File Utility and register the destination folder for the scanned image data.
- 3 Register the IP address, the registration name, and the destination number of the destination computer in the scanner using a web browser or Address Editor.

Note Be sure to enter the same number in the Save folder No. field here as the save folder number (001 – 100) that was registered in the Scanner File Utility.

Refer to the On-Line Manual <Functions Edition> for more detailed information.

Before using the Send E-mail function

Register the destination name and the email address in the scanner using a web browser or Address Editor.

How to scan under Scan to PC and Send E-mail

- 1 Press the **Scanner** key to display the Select Scanner Function screen.

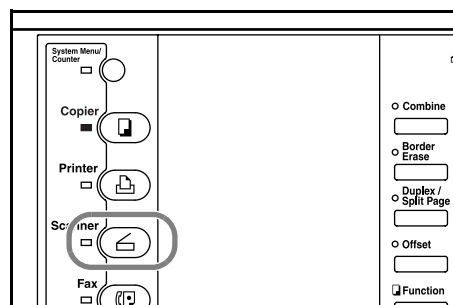

- 2 Use the ▲ and ▼ keys to select 1 Scan to PC (SEND TO PC) or 2 Send E-mail.

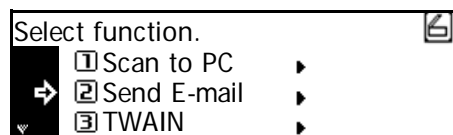

- 3 Use the ▲ and ▼ keys to move ⇨ to select your user name and press the **Enter** key.

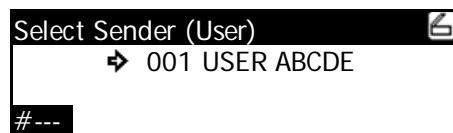

- Notes**
- If a password has been registered for the selected user, you must enter the password. Enter the password using the numeric keys and press the **Enter** key.
 - If your user name is not displayed even if the ▲ and ▼ keys are pressed, use a web browser or AddressEditor to check to see if your user name has been registered.

- 4 Use the ▲ and ▼ keys to move ⇨ to select the desired destination. An item can be selected from Send to User PC (SEND TO USER PC), Private Book, and Common Book. Select the desired item and press the **Enter** key.

When storing data in the PC of the transmitter (user):

Move ⇨ to select 2 Send to User PC (SEND TO USER PC) and press the **Enter** key.

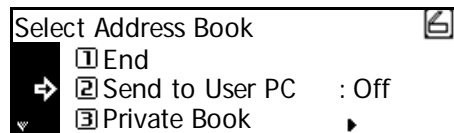

Note When registering a transmitter (user), you must set the IP address of the computer.

When selecting a destination (receiver) from the private address book:

- 1. Move ⇨ to select 3 Private Book and press the **Enter** key.

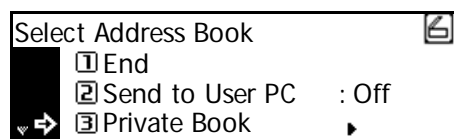

- 2. Move ⇨ to select the desired destination and press the **Enter** key.

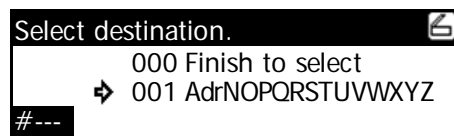

- Notes**
- If a password has been registered for the selected destination, you must enter the password. Enter the password using the numeric keys and press the **Enter** key.
 - When you enter a displayed number using the numeric keys, the confirmation screen will appear. When you press the **EnterEnter** key, the destination will be selected.

- 3. If you have selected the destination, move ⇨ to select 000 Finish to select (000 SELECT. COMPLETE) and press the **Enter** key.

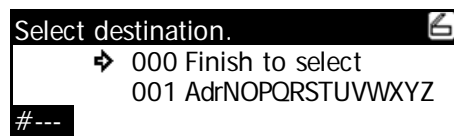

When selecting a destination (receiver) from the common address book:

Move ⇨ to select 4 Common Book and press the **Enter** key.

Operate in a similar way to the procedure for the private address book.

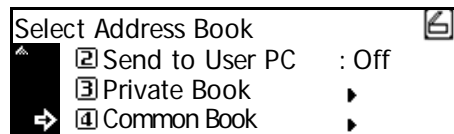

- Notes**
- For the private address book, AddressBook must be started in the computer of the transmitter (user).
 - For the common address book, the destinations must be set with a web browser or AddressEditor.
 - Up to 20 destinations can be selected at the same time.

- 5 Finally move \Rightarrow to select 1 **End** and press the **Enter** key. The scanner setting screen will appear. See **Scan setting** on page 3-6.

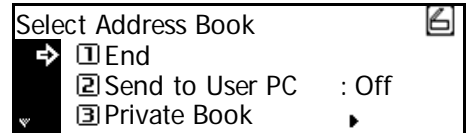

Sending information

The history of sending with the Send E-mail and Scan to PC functions is displayed.

Press the **Scanner** key, use the \blacktriangle and \blacktriangledown keys to move \Rightarrow to select 4 **Sending Information (SEND INFORMATION)**, and press the **Enter** key.

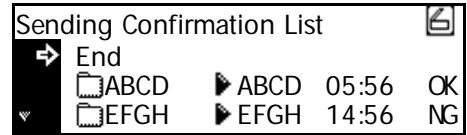

The sending confirmation list will be displayed. For more details of the history, move \Rightarrow to select the desired history and press the **Enter** key.

Scanning with TWAIN

The following explains the settings that need to be made in the scanner in order to scan using the TWAIN function.

When performing the scanning operation at the scanner

- 1 Press the **Scanner** key to display the Select Scanner Function screen.

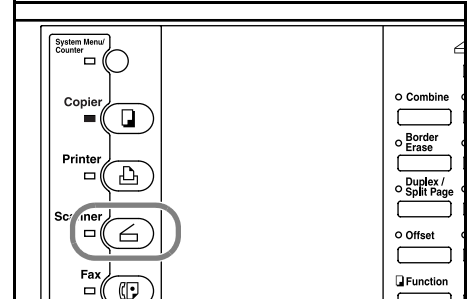

- 2 Use the ▲ and ▼ keys to move ⇨ to select 3 TWAIN and press the **Enter** key. The TWAIN Mode screen will appear.

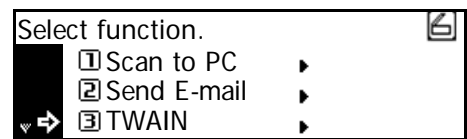

- 3 Set the original that you want to scan.

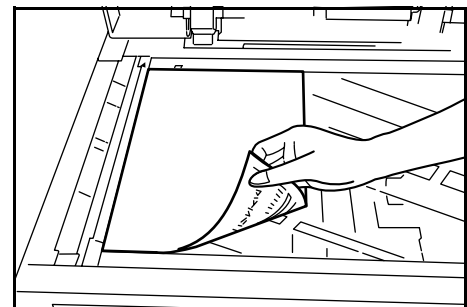

- 4 Run the TWAIN Source in the corresponding application. The main dialogue box for the TWAIN Source will appear. Make any settings that you want, click on the **[Connect]** button in the dialogue box and, once the connection to the scanner is made, click on the **[Scan]** button. Scanning will begin.

When performing the scanning operation at your computer

- 1 Run the TWAIN Source in the corresponding application. The main dialogue box for the TWAIN Source will appear. Make any settings that you want, and put a check mark in the **[Waiting Scan]** checkbox.
- 2 Click on the **[Connect]** button in the main dialogue box and, once the connection to the scanner is made, click on the **[Scan]** button.

Note Putting a check mark in the **[Waiting Scan]** checkbox will allow you to start the actual scanning operation by pressing the **Start** key at the scanner.

- 3 Set the original that you want to scan in the scanner and press the **Start** key. Scanning will begin.

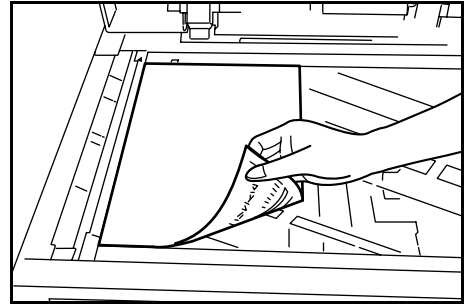

- Notes**
- Scan settings can also be made on the operation panel of the scanner. Change any settings there that you want.
 - If you enter different settings in your computer and in the scanner, the settings made on the operation panel of the scanner will take priority.

Scan setting

The scan setting screen is displayed when scanning originals. To carry out the various settings, perform the following procedures. After completing the scan settings, if you set an original in the scanner and press the **Start** key, scanning will start.

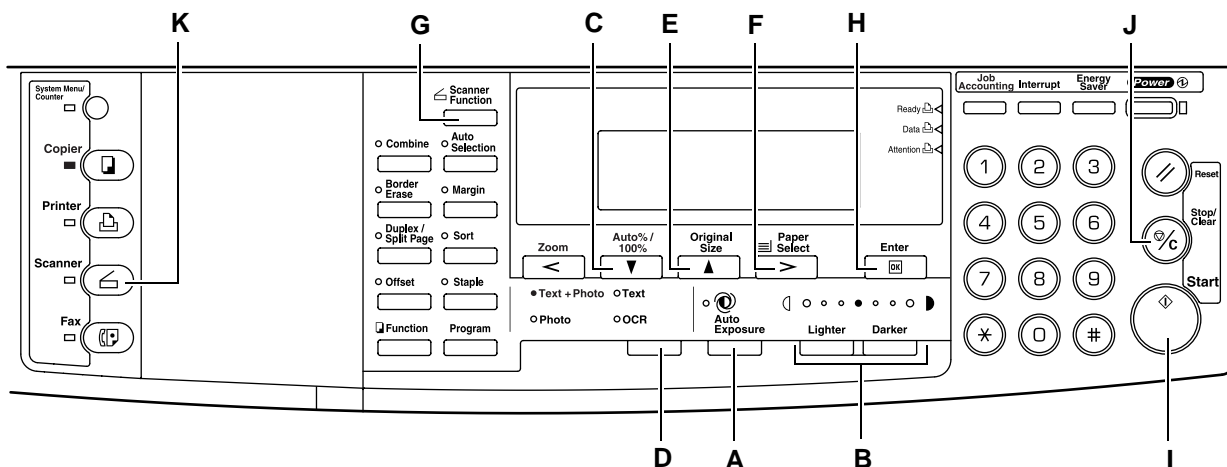

- A Auto Exposure key** — Press this key to select the automatic exposure setting.
- B Image concentration adjustment key** — Press these keys to select an exposure level.

Notes

- 7 levels in the normal mode, 13 levels in the maximum mode.
- If the automatic exposure mode is set, all the exposure indicators are off.

- C Auto%/100% key** — Press this key when you enable automatic paper orientation selection depending on the original in the gray scale mode.
- D Original Image Type key** — Press this key to select the original image type.

Note

The Photo mode cannot be selected with the Send E-mail function.

- E Original Size key** — Press this key to specify the original size.
- F Paper Select key** — Press this key to specify the transmission (image) size. The scanned original image will be automatically reduced or enlarged to the specified size.

Note

In the gray scale mode, the orientation of paper will be changed with this key. To enable again the automatic paper orientation selection depending on the original, press the **AMS/100%** key.

- G Scanner Function key** — The following settings can be adjusted.
 - Resolution
 - File type
 - Original type
 - Auto selection
 - Border erase
 - Original set direction
 - Continuous scanning
 - Output by page

Note

For details on each setting, see the Online Manual.

- H Enter (OK) key** — Press this key to confirm the setting in various setting screens.
- I Start key** — Press this key to start scanning.
- J Stop/Clear key** — Press this key to stop scanning, clear an entered value or return to the previous screen.
- K Scanner key** — If you select this key to cancel scan setting, the scan setting screen will appear.

- 1 After completing the setting, display the scan setting screen.

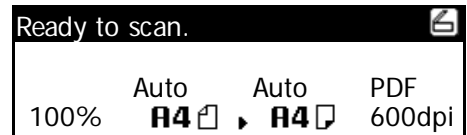

- 2 Set the original.

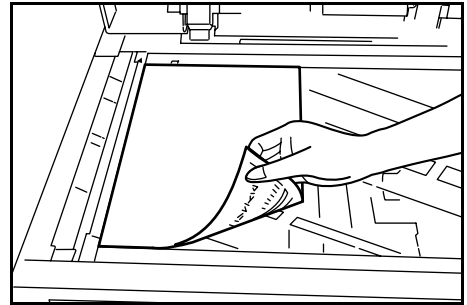

- 3 Press the **Start** key. Scanning the original starts.

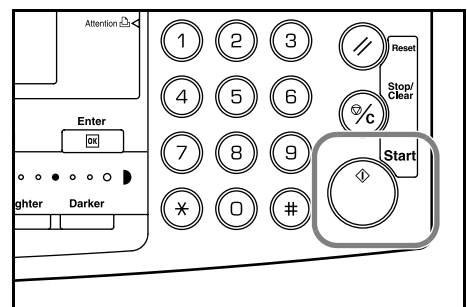

- 4 When Continue scan (MULTIPLE SCAN) is set On on the scan setting screen, the screen will appear to select whether to continue scanning originals or not when scanning is complete.

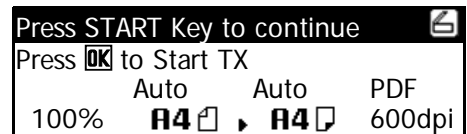

- Notes**
- To continue scanning, set the next original, change the settings as needed, and press the **Start** key.
 - Press the **Enter (OK)** key when you want to complete scanning originals.
 - When you want to cancel all scanned copies, press the **Stop/Clear** key. Screen will return to the scan setting screen of Step 1.

MEMO

**QUALITY
CERTIFICATE**

This machine has passed
all quality controls and
final inspection

